

operator manual

Digital Countertop Impinger Conveyor Oven *Series 2500*

This document includes:

- Safety Notices
- Specifications
- Installation Instructions
- Operating Instructions
- Cleaning Instructions
- Warranty Statement

Part #: 260BML
Revision: 2



Lincoln
1200 Airport North Office Park Ste. A&B
Fort Wayne, IN 46825
1-260-459-8200
1-888-417-5462 [Customer Service]
www.lincolnfp.com

IMPORTANT WARNING AND SAFETY INFORMATION



NOTE:

This manual contains important safety and installation-operation instructions. Require all operators to read this manual thoroughly before installing, operating or servicing this equipment. Improper installation, adjustment, alteration, service or maintenance can cause property damage, injury or death.



DANGER:

Do not work around conveyor belt with long hair, loose clothing, or dangling jewelry. Getting caught in the belt could result in serious injury.



DANGER:

For your safety, do not store or use gasoline or other flammable vapors or liquids in the vicinity of this or any other appliance.



DANGER:

Do not spray aerosols in the vicinity of this appliance while it is in operation.



DANGER:

If the power supply cord appears to be damaged, do not attempt to operate the unit. Contact a service agent or qualified electrician to repair!



DANGER:

Do not use parchment paper when placing food product through the appliance! Use of such materials may cause a fire and should never be placed in the appliance.

- Minimum clearances must be maintained from all walls and combustible materials.
- Keep the oven area free and clear of combustible material.
- Adequate clearance for air openings to the control chamber on both sides of the oven is required.
- Do not obstruct the ventilation holes in the control boxes and covers as these provide cooling air for the controls.
- The oven is to be operated only on the type of electricity as shown on the specification plate.
- This manual should be retained for future reference.
- The electrical wiring diagram is located under the control box covers.

Lincoln ovens are proudly manufactured in Canada.

Welbilt Canada
1177 Kamato Road
Mississauga, ON L4W 1X4

PURCHASER'S RESPONSIBILITY

It is the responsibility of the purchaser to:

1. Confirm the electric services for the oven are installed on site in accordance with the manufacturers specifications.
2. Unload, uncrate, and install the oven in its proper location in accordance with this operator manual.
3. Confirm the electric services are connected properly by a qualified installer of your choice. All such connections must be in accordance with applicable code requirements. See "Code References" section for more information.

TABLE OF CONTENTS

| | |
|--|----|
| WARRANTY AND SAFETY INFORMATION..... | 2 |
| PURCHASER'S RESPONSIBILITY..... | 3 |
| UTILITY SPECIFICATION - ELECTRIC..... | 4 |
| EXTERIOR DIMENSIONS..... | 4 |
| GENERAL INFORMATION..... | 5 |
| SPACING..... | 5 |
| ELECTRICAL GROUNDING INSTRUCTIONS..... | 5 |
| ELECTRICAL CODE REFERENCES..... | 5 |
| VENTILATION GUIDELINES..... | 5 |
| ASSEMBLY INSTRUCTIONS..... | 6 |
| STACKING INSTRUCTIONS..... | 7 |
| MOUNTING INSTRUCTIONS..... | 7 |
| DIGITAL DISPLAY ILLUSTRATION..... | 8 |
| OPERATING INSTRUCTIONS..... | 8 |
| CLEANING INSTRUCTIONS..... | 10 |
| PREVENTIVE MAINTENANCE..... | 11 |
| HOW TO OBTAIN SERVICE..... | 11 |
| CONVEYOR REMOVAL..... | 11 |
| FINGER REMOVAL AND DISASSEMBLY..... | 12 |
| FUNCTIONS..... | 12 |
| WARRANTY..... | 13 |

UTILITY SPECIFICATION

| MODEL # | Motor RPM | Input Rate | Voltage | Amps | Hz | Phase | # of wires |
|------------------|-----------|------------|------------|----------|-------|-------|------------|
| 2500-000 | 3100 | 6 kW | 208 or 240 | 27 or 24 | 60 | 1 | 3 |
| 2500-001 (Quiet) | 1750 | 6 kW | 208 or 240 | 27 or 24 | 60 | 1 | 3 |
| 2504-000 | 3100 | 6 kW | 240 | 24 | 50 | 1 | 3 |
| 2504-001 (Quiet) | 1750 | 6 kW | 240 | 24 | 50 | 1 | 3 |
| 2505-000 | 3100 | 6 kW | 380/220 | 15 | 50 | 1 | 4 |
| 2507-000 | 3100 | 6 kW | 200 | 16 | 50/60 | 3 | 5 |
| 2508-000 | 3100 | 6 kW | 380/220 | 9 | 50 | 3 | 5 |
| 2509-000 | 3100 | 6 kW | 415/240 | 8 | 50 | 3 | 5 |
| 2510-000 | 3100 | 6 kW | 220 | 27 | 60 | 1 | 3 |
| 2512-000 | 3100 | 6 kW | 400/230 | 9 | 50 | 3 | 5 |
| 2512-004 | 3100 | 6 kW | 400/230 | 9 | 50 | 3 | 5 |
| 2514-000 | 3100 | 6 kW | 240 | 24 | 50 | 1 | 3 |

* Specifications subject to change without notice.

** Ventless models are shown as 2500 000 00V 1620.

NOTE: Do not install this (these) oven(s) in any area with an ambient temperature in excess of 95° F, 35° C. Doing so will cause damage to unit.

EXTERIOR DIMENSIONS

| | A* | B** | C | D | E | F | G*** | H | I | J |
|--------|--------|-------|-------|---------|--------|-------|--------|-------|---------|-------|
| Inches | 51.125 | 31.10 | 20.50 | 17.9375 | 31.875 | 18.25 | 49.75 | 31.25 | 18.9375 | 27.50 |
| mm | 1298.6 | 789.9 | 520.7 | 455.6 | 809.6 | 463.6 | 1263.7 | 793.8 | 481.0 | 698.5 |

Note: Specifications subject to change without notice.

* "A" dimension pertains to a unit with standard conveyor and 12" (304mm) take-off shelves included on each end.

** "B" dimension pertains to a unit with standard length conveyor.

*** "G" dimension shown below pertains to a unit with an extended conveyor only.

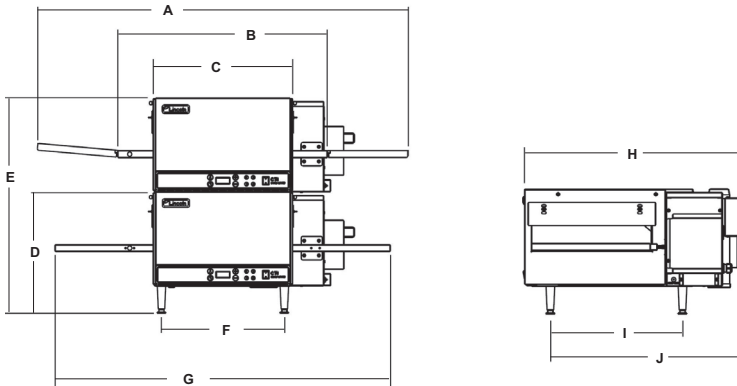

GENERAL INFORMATION

The instructions that follow are intended as a guide for preparing for the installation of the Impinger Conveyor oven.

First and foremost, each crate should be examined before signing the Bill of Lading to report any visible damage caused during shipment and account for the number of crates.

IF THERE IS APPARENT DAMAGE: United States and Canada - arrangements should be made to file a claim against the carrier. As Interstate Commerce Regulations require that the claim must be initiated by the consignee. All shipments to other countries - freight terms will be developed and extended on an individual basis.

Proper and secure storage facilities should be arranged for the oven(s) if necessary to protect it from outdoor or damp conditions at all times before installation.

SPACING

The oven must have 6 inches (152mm) of clearance from combustible surfaces. In case other equipment is located on the right side of oven, a minimum clearance of 24 inches (609mm) is required from that equipment.

FOR ALL OVENS: A 24-inch (609mm) clearance at the rear of the oven must be obtainable for service access.

ELECTRICAL GROUNDING INSTRUCTIONS



**WARNING
DOMESTIC:**

As it pertains to domestic model units, this appliance is equipped with a three-prong (grounding) plug for your protection against shock hazard and should be plugged directly into a properly grounded three-prong receptacle. Do not cut or remove the grounding prong from this plug.



**WARNING
INT'L (CE):**

This appliance must be properly grounded at time of installation. Failure to ensure that this equipment is properly grounded can result in electrocution, dismemberment or fatal injury.



WARNING:

If the supply cord appears to be damaged, do not attempt to operate unit. Contact a service agent or qualified electrician to repair.

ELECTRICAL CODE REFERENCE

IN USA

When installed, this appliance must be electrically grounded and its installation must comply with the National Electric Code, ANSI-NFPA 70, latest version, the manufacturers installation instructions, and applicable municipal building codes.

IN CANADA

All electrical connections are to be made in accordance with CSA C22.1 - Canadian Electrical Code Part 1 and/or local codes.

ALL OTHER COUNTRIES

Local electrical codes will prevail.

1. Strain relief is provided with each oven. International Dealer/Distributors provide applicable power cord/plug for each customer.
2. All pole disconnection switch 3mm open contact distance.
3. To prevent electrical shock, an equal potential bonding ground lug is provided in the back. This allows the oven to be connected to an external bonding system.
4. If used as double stack and each oven has its own disconnection switch, all switches should be close together.

VENTILATION



Local codes prevail. These are the "authority having jurisdiction" as stated by the NATIONAL FIRE PROTECTION ASSOCIATION, INC. in NFPA 96, latest edition.

For standard ovens, a ventilation hood is required to remove heat and cooking odors. Alternatively, optional electric "ventless" models are available which incorporate a catalyst to limit the emission of grease laden air to below 5mg/m³. Ventless ovens have been tested in accordance with UL710B & EPA-202 and are listed by UL to the KNLZ category. Ventless ovens should only be used for reheating purposes and should not be used to cook raw animal proteins, doing so may cause the appliance to exceed allowable grease laden air limits and/or cause damage to the catalyst. Ventless oven models can be identified by the "-V-" suffix as part of their model number, refer to the spec sheet for more details. When permitted by local code(s) and used with appropriate food products, Lincoln "ventless" ovens are not required to be installed under a ventilation hood.

Lincoln 2500 digital countertop ventless ovens equipped with a catalyst are approved for ventless operation while single or double-stacked only.

ASSEMBLY INSTRUCTIONS

INSTALL LEGS AS SHOWN

 **CAUTION:** 
Legs **MUST** be installed to ensure proper operation! Failure to do so will result in damage to unit and denied warranty claims.

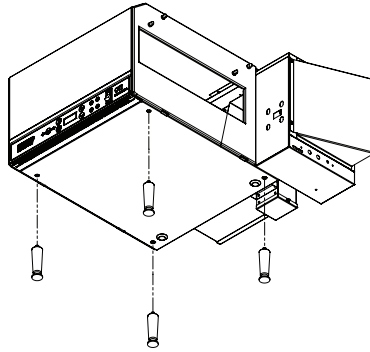

CAUTION:

Oven must be operated on an approved base only. When utilizing a double-stack configuration of ovens, the bottom unit must always be mounted on the legs provided.



CAUTION:

Before applying power to the oven, check to insure that the finger assemblies and air duct panels (upper and lower) are properly seated and have not become dislodged during shipment.

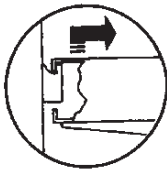

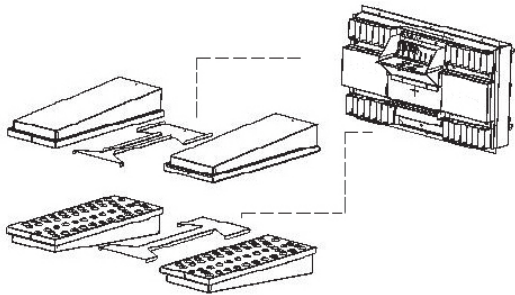

FRONT OF FINGER
ASSEMBLY PROPERLY
INSTALLED





Cut-away view of interior baking chamber
noting Finger and Plenum installation.

STACKING INSTRUCTIONS

FOR SINGLE AND DOUBLE STACK UNITS

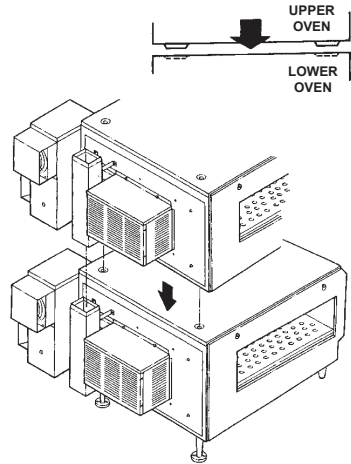
 **NOTE:** 
When stacking ovens, be sure to remove the bottom flue cap from top oven.



 **CAUTION:** 
Ovens with a Beveled front panel [Series 1300 analog ovens and Model # 2500 oven] should always be the bottom oven of a double-stack of Lincoln ovens. Models 2501 and 2502 [no bevel] should always be stacked on top of other Lincoln DCTI models [Series 1300 analog and Model 2500 Dual Voltage ovens]. Incorrect stacking arrangement may damage both ovens. Please consult with Lincoln Customer Service or our Technical Support team if unsure about stacking configuration.

 **NOTE:** When utilizing a double-stack configuration, stack the ovens so that the small "foot" on the top oven fits into the "indentation" on the top of the bottom oven.

 **CAUTION:** If you utilize a double-stack configuration, please note that each oven has its own disconnect switch. Make sure that all switches are in the "OFF" position before beginning maintenance or cleaning.



MOUNTING INSTRUCTIONS

Position the oven on the countertop and carefully mark the position of the rear legs. Remove the oven from the countertop and position the mounting rings so that the large (center) hole is where the legs of the oven were marked. Mark the position of the two small holes and remove the mounting rings.

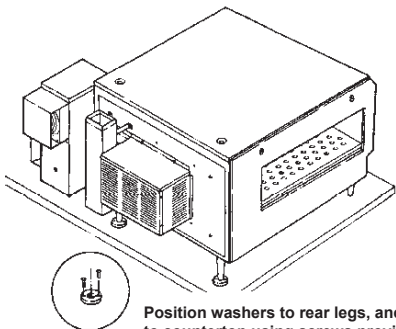
When installing on a heavy stainless steel or wood countertop, use the four 3/16" x 9/32" drive rivets. Use a .218" diameter drill (7/32") and drill at least 1/2" into a wood countertop or all the way through a steel countertop so that the rear legs are in the large holes in the mounting ring.



Position washers to rear legs, anchor them to countertop using screws provided.

 **CAUTION:** 
Install this unit in the most convenient location for ease of cleaning, maintenance, and general operation. Avoid installing in locations with drafts, close proximity to grease or vapor-producing appliances or other high-ambient heat equipment.

DIGITAL DISPLAY CONTROL PANEL

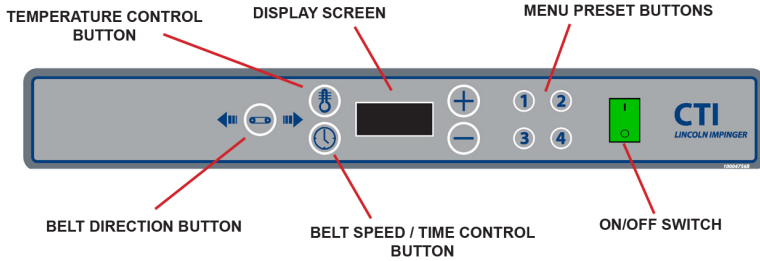

OPERATING INSTRUCTIONS



DANGER: Do not work around conveyor belt with long hair, loose clothing, or dangling jewelry. Getting caught in the belt could result in serious injury!

Prior to operating your new Countertop Oven, it is important to understand the options available to you. Following is a chart to better illustrate these options.

| CONTROLS | DESCRIPTION |
|---------------------------|--|
| Belt Speed / Time Control | Belt speed refers to how quickly the food item travels through the oven. This is shown on the display board as a unit of measure (fast to slow) between :30 seconds and 15:00 minutes. |
| Temperature Control | The Countertop Oven will allow you to increase or decrease the desired temperature setting. This is shown on the display board as a unit of measure between 90° F (32° C) - 600° F (316° C). |
| Belt Direction | The Countertop Oven will allow you to change the direction in which the conveyor belt moves. Pressing the "Belt Direction Button" will change the direction of travel between left-to-right and right-to-left options. |

POWER-UP THE OVEN

1. Turn the "On/Off Switch" to the "on" position. The oven will now run according to the previously programmed settings. Allow the oven to preheat for approximately 30 minutes.



ON/OFF SWITCH

CHANGE BELT DIRECTION

1. Press the "Belt Direction Button" to change the direction in which the conveyor belt travels.



BELT DIRECTION BUTTON

PROGRAMMING THE FOUR MENU PRESET BUTTONS

1. Press and hold the desired menu button (1-4) for approximately 5 seconds. The display screen will flash the temperature setpoint. Press the (+) or (-) button to reach the desired temperature. NOTE: All menu presets come with default settings of "Pizza" at 550° F / 6:00.

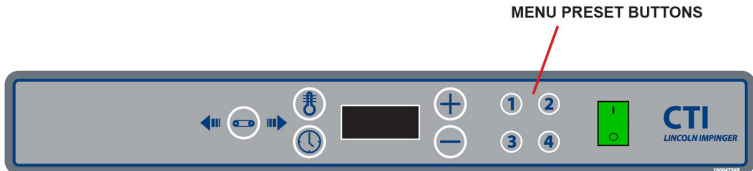

2. Press and release the menu button again to reach the time/belt speed setpoint. The display will flash the time/belt speed setpoint. Press the (+) or (-) button to reach the desired time/belt speed.
3. Press and release the menu button again to reach the menu item name. The display will flash a menu item name. Press the (+) or (-) button to locate the desired name. Once the desired name has been selected, press and release the menu button again to activate the menu setting.
NOTE: The following menu items have been preset into the software package of this oven.

- | | | |
|---------------|------------|----------|
| - Pizza | - Sandwich | - Wrap |
| - Wings | - Chicken | - Menu 1 |
| - Breakfast | - Snack | - Menu 2 |
| - Breadsticks | - Lunch | - Menu 3 |
| - Thin Pizza | - Dinner | - Menu 4 |

PROGRAMMING THE MANUAL MODE

1. Press and hold the Time and Temperature buttons for approximately 5 seconds to enter manual mode. Press the Time button to allow for changes in time. Press the (+) or (-) button to reach the desired time.

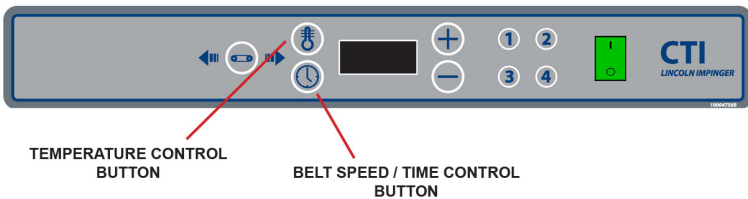

2. Press and release the Temperature button to allow for changes in temperature. Press the (+) or (-) button to reach the desired temperature. Press and release the Temperature button again to leave manual mode and activate the manual settings.

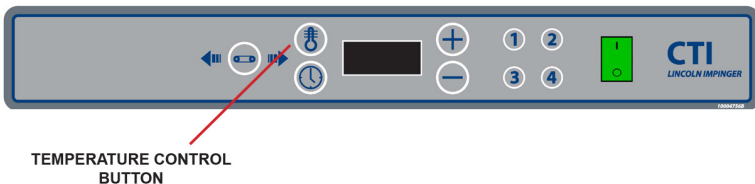

SHUTDOWN

1. Push the "On/Off Switch" to the "off" position.
2. As each Countertop oven is equipped with a 30-minute cool-down timer, the fan motor will continue to run for 30-minutes after the unit has been turned off. The fan motor will automatically stop at the end of the 30-minute cool-down period.



ON/OFF SWITCH

CLEANING INSTRUCTIONS / OPERATOR MAINTENANCE



WARNING: Disconnect power supply before servicing or cleaning this oven. Safeguard power so it cannot be accidentally restored. Failure to do so could result in dismemberment, electrocution, or fatal injury.

The Lincoln Countertop Impinger Oven contains electrical components. Before cleaning the oven, switch off and disconnect the oven from the electrical supply.

No electrical components should be subjected to moisture. Therefore, it is important the oven is wiped down carefully. NEVER throw buckets of water over the oven or subject it to pressure washing from a hose or a pressure spray. If water or other liquid is spilled on the oven, make sure that none has entered the control box area before switching on. If in doubt, call your service company.

Do not spray chemicals or cleaning liquids directly on catalyst [ventless ovens]. Clean catalyst with damp cloth only. The catalyst must be kept clean and unobstructed to be effective.

To achieve the maximum efficiency of the oven, it is necessary to keep it clean. The frequency listed is only the factory's recommendation. Your use and type of products will actually determine the frequency of cleaning.



CAUTION: Oven must be cool. Do not use power-cleaning equipment, steel wool, or wire brushes on stainless steel surfaces.

DAILY CLEANING

1. Clean exterior surfaces of the oven by wiping it down with a mild detergent and clean water, or a commercial stainless steel cleaner.
2. Clean the interior by sweeping up all loose particles then wash with a mild detergent solution and rinse with clean water.
3. Clean the conveyor belt by wiping with a clean, water-dampened cloth to remove any baked on crust or food product.



CAUTION: Do not use caustic or alkaline base cleaner on interior of oven. This will ruin the aluminized finish of the oven interior. On exterior of oven, removal of deposits of baked-on splatter, oil, grease, or light discolorations may be removed with any of several commercial cleaners. Consult with your local supplier.



CAUTION: When using cleaning solutions, be sure they meet local and national health standards.

WEEKLY CLEANING

1. Remove conveyor, disassemble and clean. See "Conveyor Removal" section for more information.
2. Remove fingers, disassemble and clean. See "Finger Removal" section for more information.

PREVENTATIVE MAINTENANCE

Although this oven has been designed to be as trouble free as possible, periodic preventative maintenance is essential to maintain peak performance. It is necessary to keep the motors, fans, and electronics free of dirt, dust, and debris to insure proper cooling. Overheating is detrimental to the life of all components mentioned.

The periodic intervals for preventive cleaning may vary greatly depending upon the environment in which the oven is operating.

You must discuss the need for preventive maintenance with your Authorized Service Agent to establish a proper program.

If there are any questions that the service agent cannot answer, please contact the Lincoln Technical Service department at (800) 678-9511.

INFORMATION ON USE OF OVEN

The Countertop Impinger Oven functions by directing high velocity streams of heated air directly upon the food products. Because air is the heat source, it is effective even on sensitive foods. Compared to conventional ovens and even convection ovens, the cooking time of products in the Countertop Impinger Oven can be as much as two (2) to four (4) times faster. Several factors may affect the cooking time of any special products such as oven temperature setting and conveyor speed. We encourage you to experiment with the oven by trying different temperature settings and belt speeds.

HOW TO OBTAIN SERVICE

If the oven fails to operate, check the circuit breaker to be sure it is turned on. Also check the fuses on the back panel to be sure that they are good before you call the Authorized Service Agency. Contact the factory at (800) 678-9511 for the name and number of the nearest Authorized Service Agency.

CONVEYOR REMOVAL & REINSTALLATION

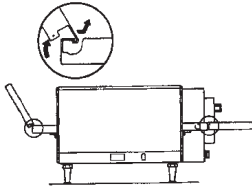

1. Remove extension shelves (if applicable).

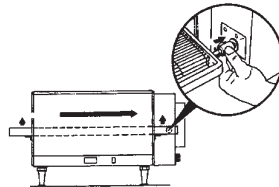

2. Push coupling away from drive lugs.
3. Remove conveyor from oven cavity.

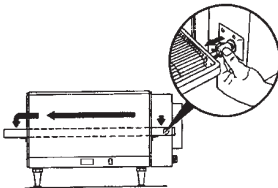

4. Reassemble in reverse order.

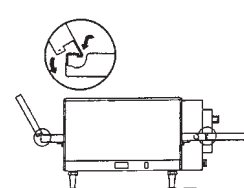

5. Install extension shelves (if applicable).



CAUTION: Conveyor and belt may be hot!

FINGERS - REMOVAL & DISASSEMBLY FOR CLEANING

DISASSEMBLY

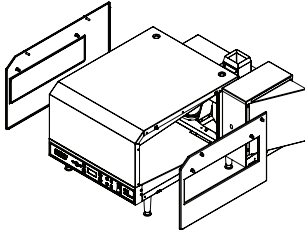

1. Remove 1/4-20 Thumbscrews (2 per panel) then pull back the panel. Lift panel off lower retaining tabs.

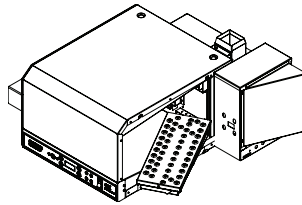

2. Lift finger assembly to clear hanger on front wall of oven. Then slide to the rear and swing out. Remove finger assembly from oven.

DISASSEMBLE FINGERS FOR CLEANING

3. Slide finger cover from housing. Lift out inner columnating plate.

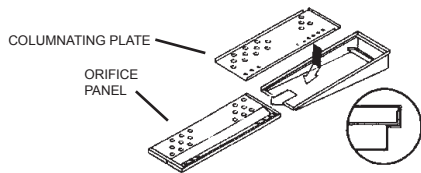

REASSEMBLY

4. Reassemble in reverse order. NOTE: Check to insure that the holes in the columnating plate are lined up with the holes in the orifice panel.
5. Reinstall fingers in the oven. Be sure that they are fully seated over the plenum flanges and the holes are pointing toward the conveyor.
6. Reinstall cover panels (see #1).

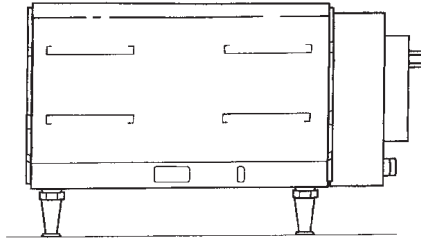

FINGER COVERS ARE MATCHED AND MAY BE INSTALLED IN ANY LOCATION.

FUNCTIONS

THERMAL CUT-OUT SWITCH

The Countertop unit includes a "safety thermal cut-out switch" for your protection. This safety related device is designed to insure that the Countertop unit will not overheat and damage the unit. In the unlikely event that the Countertop unit would exceed the specified operating temperature range, the "safety thermal cut-out switch" will activate, thus blocking power to the Countertop unit and causing it to turn off. Should this occur, contact your nearest authorized service agent for repair. For the name/ number of your nearest authorized service agent, contact Lincoln Technical Support at (800) 678-9511.



WARNING: In order to avoid a hazard due to inadvertent resetting of the thermal cutout, this appliance must not be supplied through an external switching device, such as a timer or connected to a circuit that is regularly switched on and off by the utility.

LIMITED WARRANTY FOR COMMERCIAL PRODUCTS

LIMITED WARRANTY

Lincoln Foodservice Products, LLC, ("Lincoln") warrants this product to be free from defects in material and workmanship for a period of eighteen (18) months from date of purchase.

During the warranty period, Lincoln shall, at Lincoln's option, repair, or replace parts determined by Lincoln to be defective in material or workmanship, and with respect to services, shall re-perform any defective portion of said services. The foregoing shall be the sole obligation of Lincoln under this Limited Warranty with respect to the equipment, products, and services. With respect to equipment, materials, parts and accessories manufactured by others, Lincoln's sole obligation shall be to use reasonable efforts to obtain the full benefit of the manufacturer's warranties. Lincoln shall have no liability, whether in contract, tort, negligence, or otherwise, with respect to non-Lincoln manufactured products.

WHO IS COVERED

This Limited Warranty is available only to the original purchaser of the product and is not transferable.

EXCLUSIONS FROM COVERAGE

- Repair or replacement of parts required because of misuse, improper care or storage, negligence, alteration, accident, use of incompatible supplies or lack of specified maintenance shall be excluded
- Normal maintenance items, including but not limited to, light bulbs, fuses, gaskets, O-rings, interior and exterior finishes, lubrication, conveyor belt, motor brushes, broken glass, etc. adjustments and calibrations for temperatures, speed and air flows
- Failures caused by improper or erratic voltages
- Improper or unauthorized repair
- Changes in adjustment and calibration after ninety (90) days from equipment installation date
- This Limited Warranty will not apply to any parts subject to damage beyond the control of Lincoln, or to equipment which has been subject to alteration, misuse or improper installation, accidents, damage in shipment, fire, floods, power changes, other hazards or acts of God that are beyond the control of Lincoln.
- This Limited Warranty does not apply, and shall not cover any products or equipment manufactured or sold by Lincoln when such products or commercial equipment is installed or used in a residential or non-commercial application. Installations not within the applicable building or fire codes render this Limited Warranty and any responsibility or obligations associated therein null and void. This includes any damage, costs, or legal actions resulting from the installation of any Lincoln commercial cooking equipment in a non-commercial application or installation, where the equipment is being used for applications other than those approved for by Lincoln.

LIMITATIONS OF LIABILITY

The preceding paragraphs set forth the exclusive remedy for all claims based on failure of, or defect in, products or services sold hereunder, whether the failure or defect arises before or during the warranty period, and whether a claim, however instituted, is based on contract, indemnity, warranty, tort (including negligence), strict liability, implied by statute, common-law or otherwise, and Lincoln its servants and agents shall not be liable for any claims for personal injuries, incidental or consequential damages or loss, howsoever caused. Upon the expiration of the warranty period, all such liability shall terminate. THE FOREGOING WARRANTIES ARE EXCLUSIVE AND IN LIEU OF ALL OTHER WARRANTIES, WHETHER WRITTEN, ORAL, IMPLIED OR STATUTORY. NO IMPLIED WARRANTY OF MERCHANTABILITY OR FITNESS FOR PARTICULAR PURPOSE SHALL APPLY. LINCOLN DOES NOT WARRANT ANY PRODUCTS OR SERVICES OF OTHERS.

REMEDIES

The liability of Lincoln for breach of any warranty obligation hereunder is limited to: (i) the repair or replacement of the equipment on which the liability is based, or with respect to services, re-performance of the services; or (ii) at Lincoln's option, the refund of the amount paid for said equipment or services.

Any breach by Lincoln with respect to any item or unit of equipment or services shall be deemed a breach with respect to that item or unit or service only.

WARRANTY CLAIM PROCEDURE

Customer shall be responsible to:

- Immediately advise the Dealer or Lincoln's Authorized Service Agent of the equipment serial number and the nature of the problem.
- Verify the problem is a factory responsibility. Improper installation or misuse of equipment, are not covered under this Limited Warranty.
- Cooperate with the Service Agency so that warranty service may be completed during normal working hours.
- Travel time not to exceed two (2) hours and mileage not to exceed one hundred (100) miles.

GOVERNING LAW

This Limited Warranty shall be governed by the laws of the state of Delaware, USA, excluding their conflicts of law principles. The United Nations Convention on Contracts for the International Sale of Goods is hereby excluded in its entirety from application to this Limited Warranty.



Lincoln
11200 Airport North Office Park Ste. A&B
Fort Wayne, IN 46825
1-260-459-8200
1-844-724-2273 [Welbilt Technical Support Line]
www.lincolnfp.com

THIS PAGE INTENTIONALLY LEFT BLANK.

THIS PAGE INTENTIONALLY LEFT BLANK.



WWW.WELBILT.COM

Welbilt provides the world's top chefs, and premier chain operators or growing independents with industry leading equipment and solutions. Our cutting-edge designs and lean manufacturing tactics are powered by deep knowledge, operator insights, and culinary expertise.

All of our products are backed by KitchenCare[®] – our aftermarket, repair, and parts service.

- | | | | |
|---------------------------|---------------------------|--------------------------|--------------------------|
| ▶ CLEVELAND | ▶ FITKITCHEN [™] | ▶ KOLPAK [®] | ▶ MERCO [®] |
| ▶ CONVOTHERM [®] | ▶ FRYMASTER [®] | ▶ LINCOLN | ▶ MERRYCHEF [®] |
| ▶ DELFIELD [®] | ▶ GARLAND | ▶ MANITOWOC [®] | ▶ MULTIPLEX [®] |